

Mills Machine Company, Inc.
Custom Manufacturing, Customer Service and Rapid Response.

201 N. Oklahoma - P.O. Box 1514
Shawnee, OK 74802-1514
Tel: (405) 273-4900
Fax: (405) 273-4956
Toll Free: 1-800-654-2703



Horizontal Directional Drilling Products - Section 5

Horizontal Drilling	5-2
Products	5-2
Roller Cone Horizontal Hole Openers	5-2
Drag Type Horizontal Hole Openers	5-2
Bullet Type Horizontal Hole Openers	5-2
Horizontal Roller Rock Head (HRR)	5-3
HDD Components	5-4
Step Construction - HDD	5-4
Apex (Chevron) Construction - RQT	5-5
Claw (Bullet) Construction - HDR	5-5

Please call for custom options and other accessories.

Visit our web site:
www.MillsMachine.com

Mills Machine Co. Inc.
P.O. Box 1514
Shawnee, OK 74802

Toll-Free: 800-654-2703
Local: 405-273-4900
Fax: 405-273-4956

5-1

Horizontal Drilling

Horizontal Drilling continues to be the most popular method of installing electrical cable, fiber optics, utility conduits, and irrigation lines in industrial, commercial and residential applications. This technology eliminates the need for open trenching to install utility lines and surface obstructions can be avoided with minimal environmental disturbance and limited interruptions to traffic or services.

Mills Machine has been manufacturing horizontal drilling bits, hole openers, and horizontal road boring bits since 1979. We also offer two types of Horizontal Road Boring bits, Free Bore and Casing Push type. Both of these designs feature steel tooth or tungsten carbide button roller cone bit segments with sealed bearings in new, retip, or rerun condition.

This catalog section features Claw, Blade, or Roller Horizontal Holeopeners and Back Reamers.

Roller Cone Horizontal Hole Openers

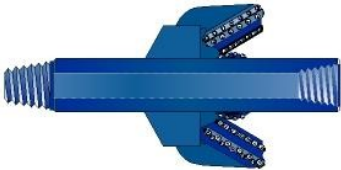

Mills Machine has over 45 years of experience in manufacturing our custom designed horizontal roller holeopeners, which are, available in sizes from 6" to 120" (150 mm to 3 Meters) and larger. We custom manufacture these holeopeners to meet your specific requirements. These ruggedly constructed units are made from 4142 heat treated alloy steel and the roller rock bit cutters of your choice.

The horizontal holeopeners are available in single stage, two stages or multiple stage depending on the pilot hole and the finished hole size. The lead and trailing necks can be as long as you desire with breakout flats or lugs as needed. Circulation can be standard or reverse for horizontal or raised bore drilling and circulation can be fluid or air depending on your rig capabilities.

Roller Cone Horizontal Holeopeners are made with tricone roller rock bits and are available in Steel Tooth or TCI Button, in new, retip or rerun condition and with open or sealed journal bearings.

Drag Type Horizontal Hole Openers

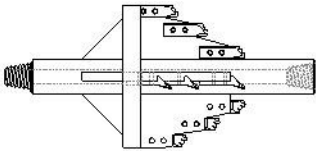

Mills Machine also manufactures large drag (blade) Hole Openers for horizontal drilling using replaceable bolt-on teeth in a step tooth or chevron apex tooth construction or a combination of teeth and bullet bits. This type of reamer is designed for soft to medium formations and can be made in any size with any thread, front or back. Another option to this bit is to put cutters and jets on the back side of the bit if you have to reverse out of the hole.

Bullet Type Horizontal Hole Openers

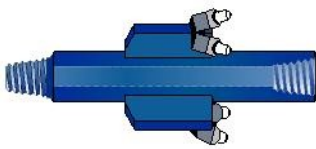

Truly one of the most versatile bits that we manufacture is the Bullet Type Reamer. Designed for hard compacted clay to soft limestone this rugged bit with replaceable carbide cutters offers the most capability and convenience for the money. It is a very aggressive cutting bit that will increase your production while reducing your overhead.

Please call for custom options and other accessories.

5-2

Toll-Free: 800-654-2703
Local: 405-273-4900
Fax: 405-273-4956

Mills Machine Co. Inc.
P.O. Box 1514
Shawnee, OK 74802

Visit our web site:
www.MillsMachine.com

Horizontal Roller Rock Head (HRR)

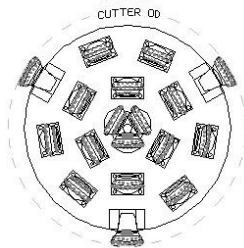
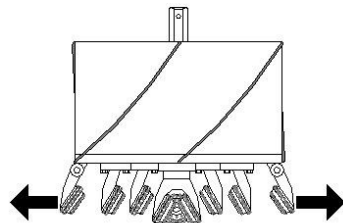
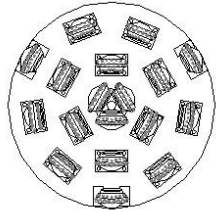
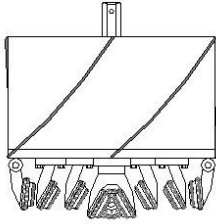

Mills Machine has been custom manufacturing horizontal hard rock drilling bits for over 20 years. We make two types of HRR bits: a Free Bore and Casing Push type. Both of these designs feature steel tooth or tungsten carbide button roller cone bit segments with sealed bearings. We offer new or economical reconditioned roller cones manufactured by major oil field bit companies.

Free Bore Bits feature either fabricated fixed cutters that can be cut off and replaced or bolt-on, field-replaceable cutters. These bits can be manufactured to any size you need.

Casing Push Bits feature gage cutters that open out when rotated to the right (clockwise) to cut a larger hole than the outside diameter of the casing or pipe. If warranted, the bit can be rotated to the left (counter clockwise), closing the cutters and making it possible to retract the bit, while leaving the casing in the hole. These bits feature either fabricated fixed cutters that can be cut off and replaced or bolt-on, field-replaceable cutters. Casing Push Bits are typically 18" or larger.

The Casing Push Bit design features Mills Cam Lok technology which enables the hinged roller gage cutter to positively lock into place and then close back into the body for retraction from the hole. Normally, two small water lines are tacked onto the top of the casing to provide water or drilling fluids to keep the roller cones cool and to flush small rock cuttings out of the hole. The common drive for these types of bits are solid flight augers, but rotary threaded drill rod or jet augers (drill rod with flighting) are also available. These bits offer an economical solution to your hard rock boring needs.

We can also manufacture these bits in Drag (blade) Type, for boring soft to medium formations, and Bullet Type, for soft to medium hard formations. Drag Type Bits feature bolt-on, field-replaceable, carbide-tipped teeth. Bullet Type Bits fall into a category somewhere between drag type bits and roller type heads. This versatile, fast-cutting bit is capable of drilling up to 10,000 psi rock.

Please call for custom options and other accessories.



Visit our web site:
www.MillsMachine.com

Mills Machine Co. Inc.
P.O. Box 1514
Shawnee, OK 74802

Toll-Free: 800-654-2703
Local: 405-273-4900
Fax: 405-273-4956

5-3

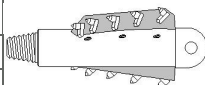
HDD Components

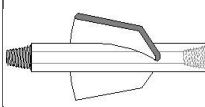
Description	Part #	Weight		Diagram
		Lbs.	Kg.	
Winged Claw Backreamer				
6" Claw Backreamer	BRC600	-		
8" Claw Backreamer	BRC800	-		
10" Claw Backreamer	BRC1000	-		
12" Claw Backreamer	BRC1200	-		
14" Claw Backreamer	BRC1400	-		
16" Claw Backreamer	BRC1600	-		
18" Claw Backreamer	BRC1800	-		
20" Claw Backreamer	BRC2000	-		
22" Claw Backreamer	BRC2200	-		
24" Claw Backreamer	BRC2400	-		
Roller Cone Backreamers				
6" Roller Cone Backreamer	BRR600	-		
8" Roller Cone Backreamer	BRR800	-		
10" Roller Cone Backreamer	BRR1000	-		
12" Roller Cone Backreamer	BRR1200	-		
14" Roller Cone Backreamer	BRR1400	-		
16" Roller Cone Backreamer	BRR1600	-		
18" Roller Cone Backreamer	BRR1800	-		
20" Roller Cone Backreamer	BRR2000	-		
22" Roller Cone Backreamer	BRR2200	-		
24" Roller Cone Backreamer	BRR2400	-		
Spiral Blade Backreamer				
Mills Machine Spiral Blade Backreamers feature carbide-tipped drag blades designed for drilling in soft to medium formations.				
6" Drag Blade Backreamer	BRD600	-		
8" Drag Blade Backreamer	BRD800	-		
10" Drag Blade Backreamer	BRD1000	-		
12" Drag Blade Backreamer	BRD1200	-		
14" Drag Blade Backreamer	BRD1400	-		
16" Drag Blade Backreamer	BRD1600	-		
18" Drag Blade Backreamer	BRD1800	-		
20" Drag Blade Backreamer	BRD2000	-		
22" Drag Blade Backreamer	BRD2200	-		
24" Drag Blade Backreamer	BRD2400	-		

Step Construction - HDD

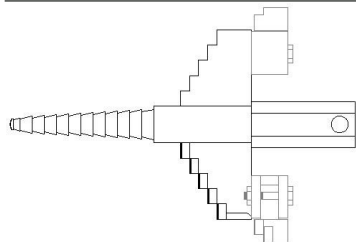

Step Construction Bits are designed to cut soft to medium-soft formations. It features a carbide step type design and a carbide-tipped spiral pilot neck. The swept back tapered design keeps the bit centered in the hole. This type of bit should be used in dirt, clay, sand rock, and light sandstone formations. The HDD is known for its fast penetration due to its stair step blades, which produce small cuttings that are easily removed from the hole.

Please call for custom options and other accessories.

5-4

Toll-Free: 800-654-2703
Local: 405-273-4900
Fax: 405-273-4956

Mills Machine Co. Inc.
P.O. Box 1514
Shawnee, OK 74802

Visit our web site:
www.MillsMachine.com

Apex (Chevron) Construction - RQT

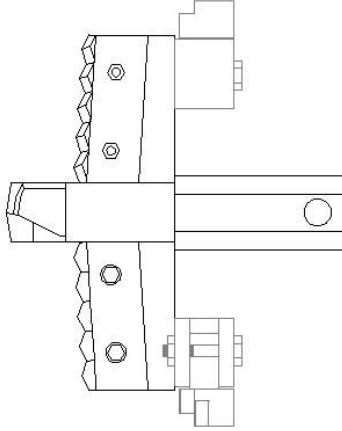

Apex (Chevron) Construction Bits are designed for soft to medium formations. They feature bolt-on, field-replaceable blades with apex carbide inserts. The self-centering heavy duty pilot bit is carbide-tipped and can be unscrewed for easy replacement. The shape of the blades and carbide inserts offer aggressive yet durable cutting action.

Claw (Bullet) Construction - HDR

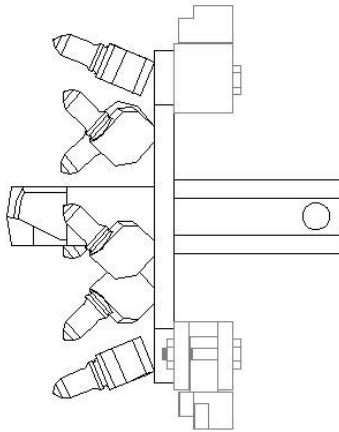

Claw (Bullet) Construction Bits are designed for medium to hard formations. They feature carbide-tipped bullet cutters which rotate in their holders providing a self-sharpening action. These inexpensive cutters are field-replaceable and are rated at up to 10,000 PSI rock. This durable, aggressive bit can be used to cut hard compacted clay, sand rock, shale, and soft limestone formations with a rapid penetration rate.

Please call for custom options and other accessories.

Visit our web site:
www.MillsMachine.com

Mills Machine Co. Inc.
P.O. Box 1514
Shawnee, OK 74802

Toll-Free: 800-654-2703
Local: 405-273-4900
Fax: 405-273-4956

5-5